

Fastline 35-50W led-module asymmetrisch 25° links 1500mm 4000K wit

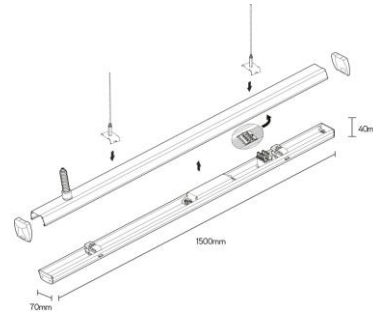

Artikel nummer FLM50DASL4

elektrotechnische eigenschappen

Aansluitspanning	220-240V
Vermogen	35-50W
Frequentie	50/60Hz
Lumen/Watt	180lm/W
Driver	Tridonic
Power factor	>0,95
Dimbaar	nee
Noodunit	nee

eigenschappen behuizing

Afmetingen	1500x70x40
IP-waarde	IP40
Slagvastheid	IK07
Kleur	RAL9016
Isolatieklasse	I
Werktemperatuur	-25 - 60°C

lichttechnische eigenschappen

Lumenoutput	6300-9000lm
Kleurtemperatuur	4000k
Gradenbundel	asym 25° links
Kleurweergave	CRI>83
Kleurtolerantie	<3 SDCM
Flicker-Free	ja
Lumenbehoud	L80B20 50.000h
Flux code	62 89 98 97 102
Led type	SMD2835

overige eigenschappen

Garantie	5 jaar

lichtdiagram

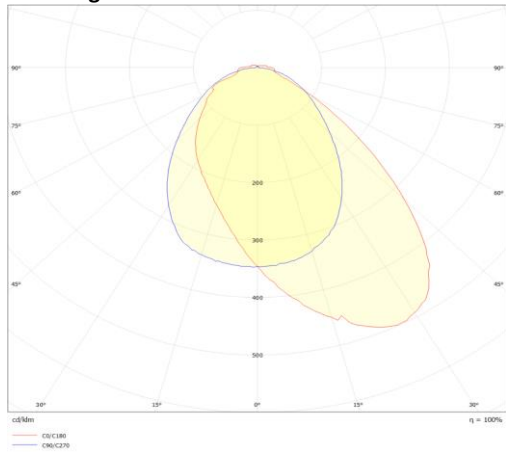

project toepassing

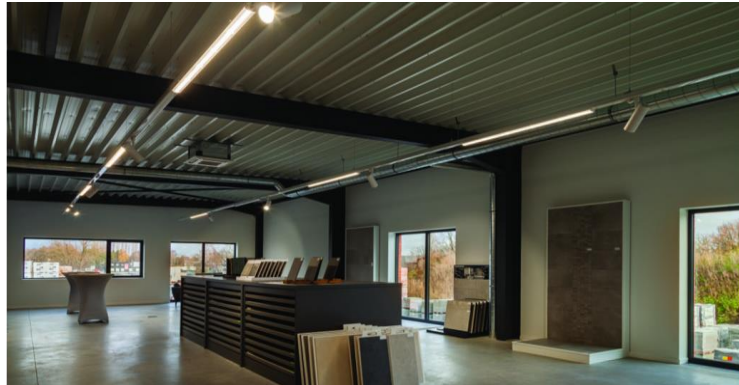

accessoires

- FLM3FR06 3-faserail module 600mm wit
- FLM3FR15 3-faserail module 1500mm wit
- FLMMWD07 sensor 1500mm met 8m beweging- en daglichtdetectie DALI
- FLR15W08 8-draads draagprofiel 1500mm wit
- FLR15W08E 8-draads draagprofiel 1500mm wit voor eindkap
- FLR30W08 8-draads draagprofiel 3000mm wit
- FLR06W08 draagprofiel 600mm wit



lastenboekomschrijving

0