

**GU10 pro**

4000K 7W 60° CRI>83 dimbaar alu

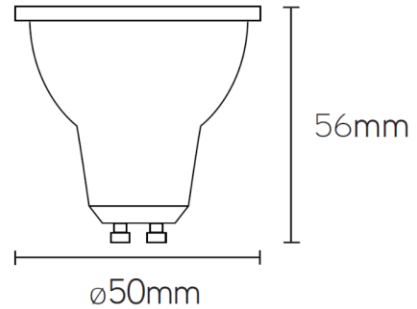

**Artikel nummer** **GU10LL4060**

**elektrotechnische eigenschappen**

Aansluitspanning	200-240V
Vermogen	7W
Lumen/Watt	85lm/W

**eigenschappen behuizing**

Afmetingen	Ø50x55,5
IP-waarde	IP20
Kleurtolerantie	SDCM<3

**lichttechnische eigenschappen**

Lumenoutput	595lm
Kleurtemperatuur	4000k
Gradenbundel	36°
Kleurweergave	>83
Kleurtolerantie	SDCM<3
Flux code	
Aantal led-chips	1xCOB
Dimbaar	Triac

**overige eigenschappen**

Garantie	3 jaar

### lichtdiagram

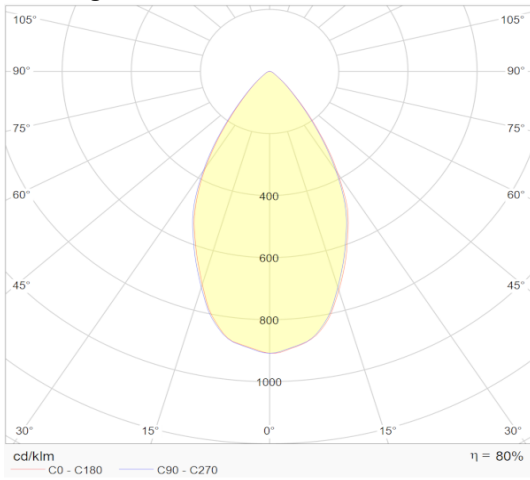

### project toepassing



### lastenboekomschrijving

0