

Industrial Line - Highbays

Artikelnummer S2ERFL2475A - Reflector 75gr alu voor Smart-IE 200-240W

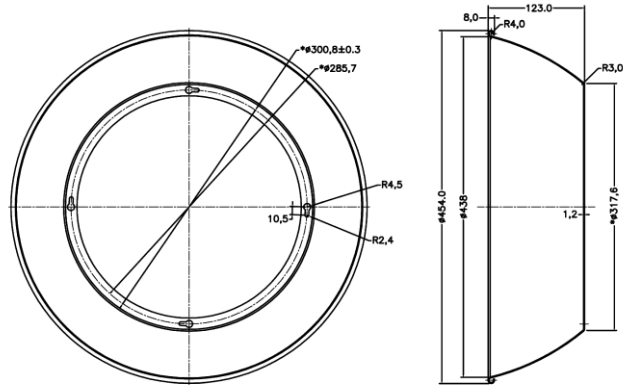

Eigenschappen behuizing

Afmetingen (mm)	454x454x123 mm
Bruto gewicht (kg)	1,5
Kleur	Alu

Buitendiameter (mm)	454
IP waarde	65
Behuizing	Aluminium