

SAPP

LSP201200263WDA

SAPP armatuur 1200mm 26W 3000K wit DALI

Linear Line - Lichtlijn armaturen

ETIM: EC002892

Armatuur voor SAPP plafond wit RAL9010 met opaal diffuser 110° DALI dimbaar en Wieland connector GST18i5

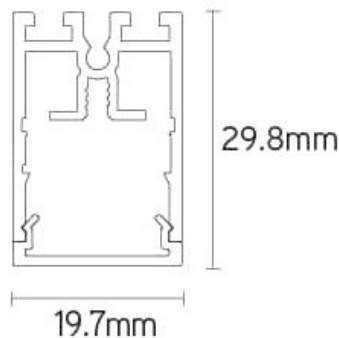

Elektrische eigenschappen	
Voeding (Vac)	200~240
Voeding (Vdc)	200~240
Frequentie (Hz)	50~60
Systeem vermogen (W)	26,4
Led vermogen (W)	26
Power factor	0,95
Merk driver	Boke
Driver referentie	BK-DAL030
Driver inbegrepen	Ja
Driver CC/CV	CC
Isolatieklasse	2
Driver in/extern	Extern
Doorvoerbedrading	Nee
Met aansluitkabel	Cca
Kabel lengte (m)	1
Geïsoleerde driver	Ja
SELV driver	Ja
Driver efficiëntie (%)	88,5
Driver THD < (%)	10
Driver uitgangsvoltage (VDC)	28~42
Driver uitgangsstroom (mA)	700~750
Dimbaar	DALI2
Flicker free	Ja
PstLM flicker index	1
SVM strobo effect	0,4
Inrush current @ 230Vac	17,8A 197µs
B16 #	37
C16 #	62
ENEC	Nee

Lichttechnische eigenschappen	
Reflector (°)	110
CCT (K)	3000~3000
CRI >	90
UGR <	22
SDCM <	3
Lumen output (Lm)	2706
Lm/W	110
Fotobio klasse	RG0
Energie klasse	E
Garantie (jaar)	5
Levensduur L80B50	75.000
Ledchip	SMD2835
Merk ledchip	Sanan

Eigenschappen behuizing	
Afmetingen (mm)	1200x19,7x29,8 mm
Bruto gewicht (kg)	1,5
IP waarde	20
IK waarde	06
Kleur	Wit
RAL kleur	9010
Behuizing	Aluminium
Diffuser	PC opaal
Ta (°C)	-20~45
UV bestendig	Ja
Chloor bestendig	Nee
HACCP	Nee
Ball proof	Nee

SAPP

SAPP armatuur 1200mm 26W 3000K wit DALI

Linear Line - Lichtlijn armaturen

LSP201200263WDA

ETIM: EC002892

Lumen distributie

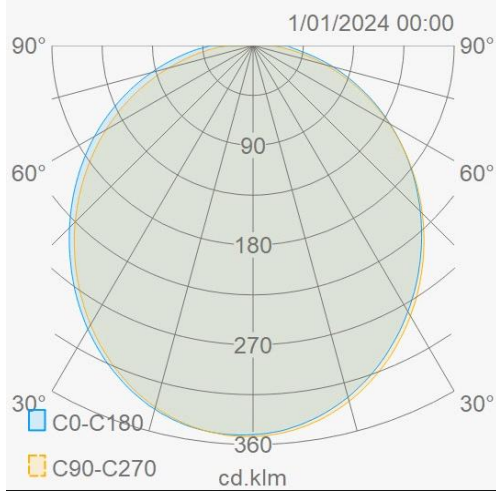

Distance curve

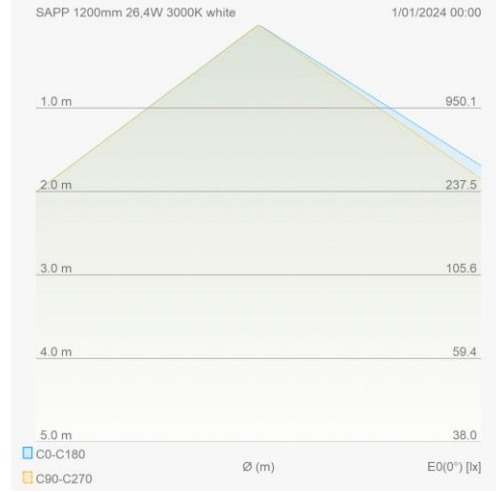

Aansluitschema

