

SAPP

LSP200900204WUG

SAPP armatuur 900mm 18W 4000K UGR<19 wit

Linear Line - Lichtlijn armaturen

Armatuur voor SAPP plafond wit RAL9010 met wit raster 60° UGR<19 en Wieland connector GST18i3

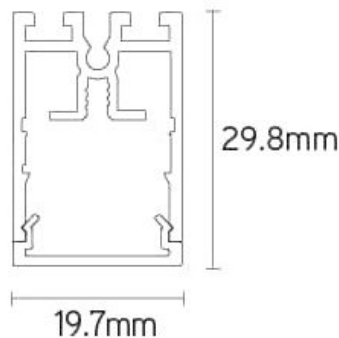

Elektrische eigenschappen	
Voeding (Vac)	200~240
Voeding (Vdc)	200~240
Frequentie (Hz)	50~60
Systeem vermogen (W)	19,8
Led vermogen (W)	18
Power factor	0,95
Merk driver	Boke
Driver inbegrepen	Ja
Driver referentie	BK-CWL022
Driver CC/CV	CC
Isolatieklasse	2
Driver in/extern	Extern
Doorvoerbedrading	Nee
Met aansluitkabel	Cca
Kabel lengte (m)	1
Geïsoleerde driver	Ja
SELV driver	Ja
Driver efficiëntie (%)	85,5
Driver THD < (%)	10
Driver uitgangsvoltage (VDC)	28~42
Driver uitgangsstroom (mA)	400~450
Dimbaar	Nee
Flicker free	Ja
PstLM flicker index	1
SVM strobo effect	0,4
Inrush current @ 230Vac	10,5A 248µs
B16 #	49
C16 #	82
ENEC	Nee

Lichttechnische eigenschappen	
Reflector (°)	60
CCT (K)	4000~4000
CRI >	90
UGR <	19
SDCM <	3
Lumen output (Lm)	2362
Lm/W	125
Fotobio klasse	RG0
Energie klasse	E
Garantie (jaar)	5
Levensduur L80B50	75.000
Ledchip	SMD2835
Merk ledchip	Sanan

Eigenschappen behuizing	
Afmetingen (mm)	900x19,7x29,8 mm
Bruto gewicht (kg)	1,1
IP waarde	20
IK waarde	06
Kleur	Wit
RAL kleur	9010
Behuizing	Aluminium
Diffuser	PMMA transparant
Ta (°C)	-20~45
UV bestendig	Ja
Chloor bestendig	Nee
HACCP	Nee
Ball proof	Nee

SAPP

LSP200900204WUG

SAPP armatuur 900mm 18W 4000K UGR<19 wit

Linear Line - Lichtlijn armaturen

Lumen distributie

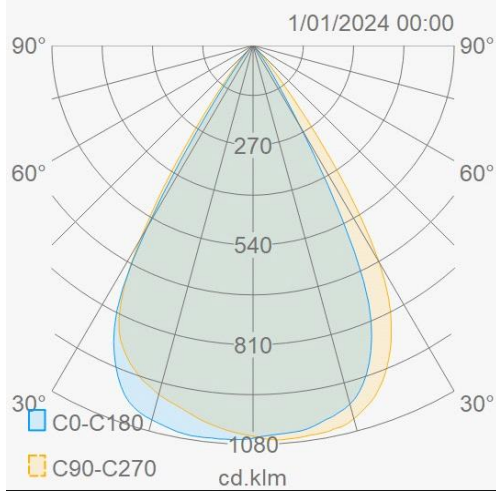

Distance curve

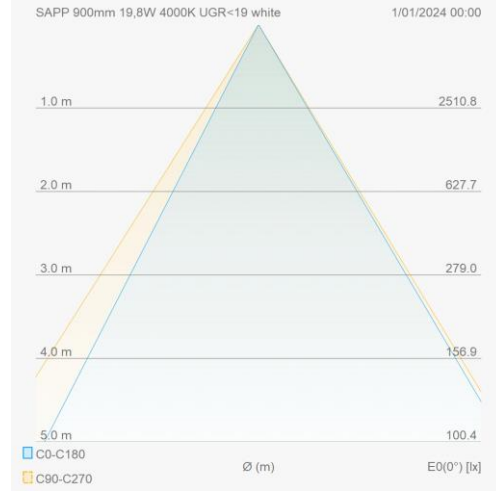

Aansluitschema

