

## SAPP

LSP200900203BUGDA

SAPP armatuur 900mm 18W 3000K UGR<19 zwart DALI

Linear Line - Lichtlijn armaturen

Armatuur voor SAPP plafond zwart RAL9005 met zwart raster 60° UGR<19 DALI dimbaar en Wieland connector GST18i5

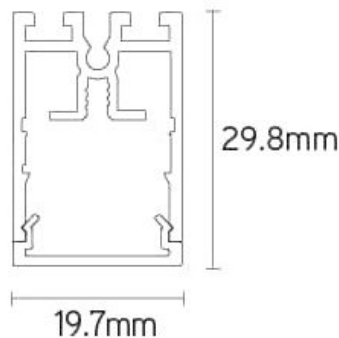

Elektrische eigenschappen	
Voeding (Vac)	200~240
Voeding (Vdc)	200~240
Frequentie (Hz)	50~60
Systeem vermogen (W)	19,8
Led vermogen (W)	18
Power factor	0,95
Merk driver	Boke
Driver inbegrepen	Ja
Driver referentie	BK-DAL030
Driver CC/CV	CC
Isolatieklasse	2
Driver in/extern	Extern
Doorvoerbedrading	Nee
Met aansluitkabel	Cca
Kabel lengte (m)	1
Geïsoleerde driver	Ja
SELV driver	Ja
Driver efficiëntie (%)	85,5
Driver THD < (%)	10
Driver uitgangsvoltage (VDC)	28~42
Driver uitgangsstroom (mA)	400~450
Dimbaar	DALI2
Flicker free	Ja
PstLM flicker index	1
SVM strobo effect	0,4
Inrush current @ 230Vac	10,5A 248µs
B16 #	49
C16 #	82
ENEC	Nee

Lichttechnische eigenschappen	
Reflector (°)	60
CCT (K)	3000~3000
CRI >	90
UGR <	19
SDCM <	3
Lumen output (Lm)	2065
Lm/W	115
Fotobio klasse	RG0
Energie klasse	E
Garantie (jaar)	5
Levensduur L80B50	75.000
Ledchip	SMD2835
Merk ledchip	Sanan

Eigenschappen behuizing	
Afmetingen (mm)	900x19,7x29,8 mm
Bruto gewicht (kg)	1,1
IP waarde	20
IK waarde	06
Kleur	Zwart
RAL kleur	9005
Behuizing	Aluminium
Diffuser	PMMA transparant
Ta (°C)	-20~45
UV bestendig	Ja
Chloor bestendig	Nee
HACCP	Nee
Ball proof	Nee

## SAPP

LSP200900203BUGDA

SAPP armatuur 900mm 18W 3000K UGR<19 zwart DALI

Linear Line - Lichtlijn armaturen

### Lumen distributie

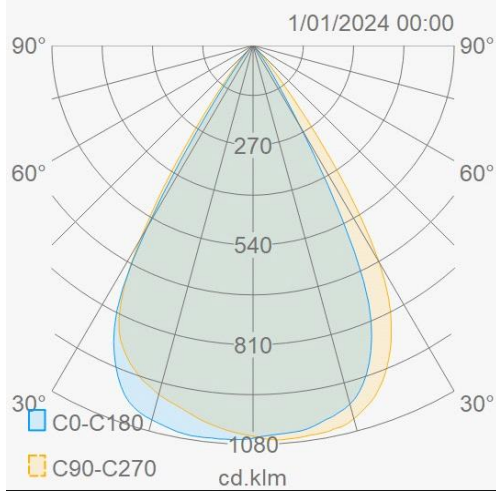

### Distance curve

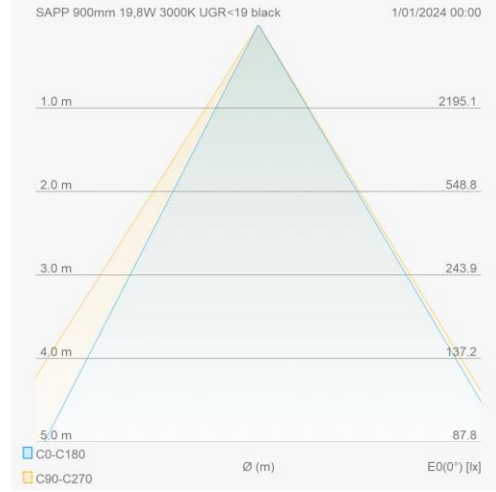

### Aansluitschema

