

Utility Line - Trunk system

Artikelnummer FLM70D0904 - Fastline led module 1,5m 55-70W 90gr 4000K

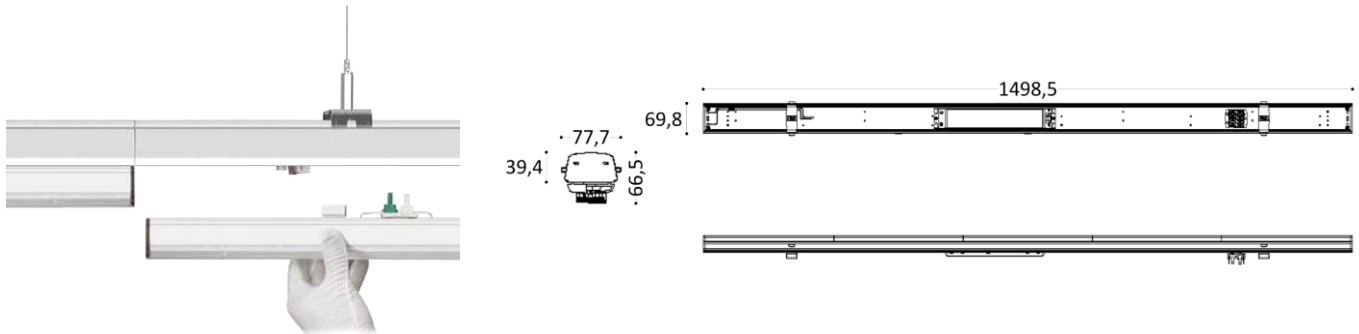

Fastline led module 1,5m met niet dimbare driver instelbaar op 55/60/65/70W

Elektrische eigenschappen

Voeding (Vac)	220-240	Voeding (Vdc)	200-240
Frequentie (Hz)	50-60	Systeem vermogen (W)	70
Vermogen instelbaar	Ja	Power factor	0,95
Merk driver	Boke	Driver referentie	BK-BAN075-A040
Driver inbegrepen	Ja	Driver CC/CV	CC
Isolatieklasse	1	Driver in/extern	Intern
Doorvoerbedrading	Ja	Doorvoerbedrading mm ²	2,5
Driver efficiëntie (%)	94	Driver THD < (%)	10
Driver uitgangsstroom (mA)	400	Dimbaar	Nee
Flicker free	Ja	PstLM flicker index	1
SVM strobo effect	0,4	Inrush current	25,5A 302µs
B16 #	12	C16 #	20
ENEC	Nee		

Lichttechnische eigenschappen

Reflector (°)	90	CCT (K)	4000
CRI >	83	SDCM <	3
Lumen output (Lm)	12600	Lm/W	180
Fotobio klasse	RG0	Energie klasse	C
Garantie (jaar)	5	Levensduur L90	39.000
Levensduur L80	60.000	Ledchip	SMD2835
Merk ledchip	Ebright		

Eigenschappen behuizing

Afmetingen (mm)	1500x70x40 mm	Bruto gewicht (kg)	1,88
Bulkverpakking	10	IP waarde	40
IK waarde	07	Kleur	Wit
RAL kleur	9016	Behuizing	Plaatstaal
Diffuser	PC	Ta (°C)	-25~+40
UV bestendig	Ja	Glow wire test (°C)	850

Lumenwaardes

55W - 4000K - 9900lm - dip-switch	60W - 4000K - 10800lm - dip-switch
65W - 4000K - 11700lm - dip-switch	70W - 4000K - 12600lm - dip-switch

Utility Line - Trunk system

Artikelnummer FLM70D0904 - Fastline led module 1,5m 55-70W 90gr 4000K

Lumen distributie

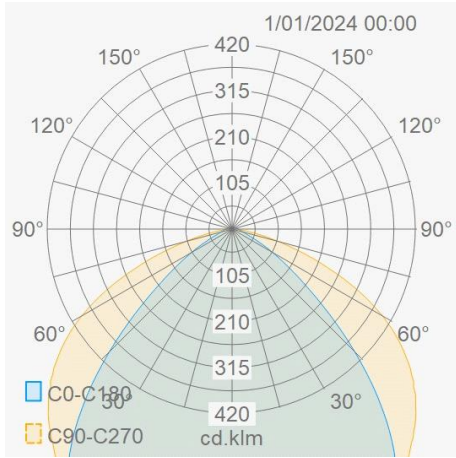

Distance curve

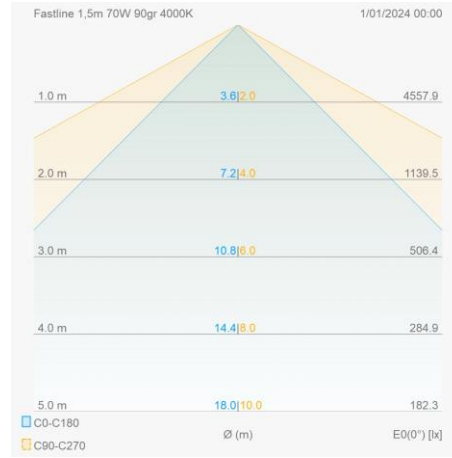

Montage toebehoren

FLR15W08

Fastline draagprofiel 1,5m 8-draads wit



FLR15W08E

Fastline draagprofiel 1,5m 8-draads eindprofiel wit



Aansluitschema

