

## Outdoor Line - Terrein verlichting

Artikelnummer E2T200S23 - Streetlight Estrada 200W 3000K grijs lens 2

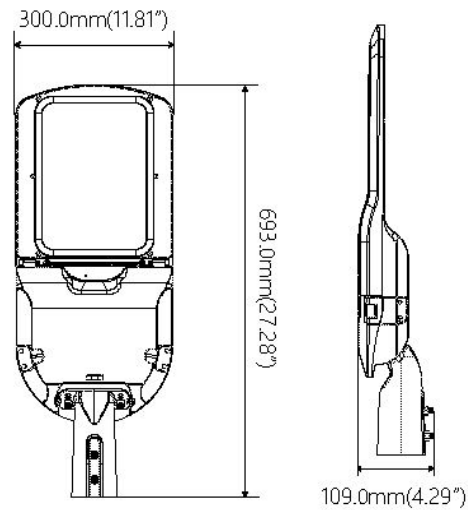

Paaltoparmatuur in aluminium behuizing IP66 IK08 grijs RAL9006 met lens type 4 86x143gr. Geschikt voor horizontale of verticale paalbevestiging van 60mm. 7 jaar garantie.

### Elektrische eigenschappen

Voeding (Vac)	120~277	Frequentie (Hz)	50~60
Systeem vermogen (W)	200	Power factor	0,97
Merk driver	Sosen	Driver inbegrepen	Ja
Driver referentie	SS-200EP-56B	Driver CC/CV	CC
Isolatieklasse	1	Driver in/extern	Intern
Doorvoerbedrading	Nee	Kabelingang mm <sup>2</sup>	1,5~4
Driver efficiëntie (%)	92	Driver THD < (%)	10
Driver uitgangsvoltage (VDC)	36~56	Driver uitgangsstroom (mA)	2800~5600
Dimbaar	Nee	Flicker free	Ja
PstLM flicker index	1	SVM strobo effect	0,4
Inrush current	110A 200µs	B16 #	5
C16 #	9	ENEC	Ja
Overspanningsbeveiliging (kV)	10		

### Lichttechnische eigenschappen

Reflector (°)	86x143	CCT (K)	3000~3000
CRI >	70	SDCM <	5
Lumen output (Lm)	28658	Lm/W	150
Energie klasse	D	Garantie (jaar)	7
Levensduur L90B10	46000	Levensduur L80B10	96000
Ledchip	3030	Merk ledchip	Lumileds

### Eigenschappen behuizing

Afmetingen (mm)	693x300x109 mm	Bruto gewicht (kg)	6,65
IP waarde	66	EPA	0,165
IK waarde	08	Kleur	Grijs
RAL kleur	9006	Behuizing	Aluminium
Diffuser	Glas	Richtbaar	Ja
Ta (°C)	-30~50	UV bestendig	Ja
Glow wire test (°C)	850	Schroeven	RVS L304

**Outdoor Line - Terrein verlichting**

Artikelnummer E2T200S23 - Streetlight Estrada 200W 3000K grijs lens 2

**Lumen distributie**

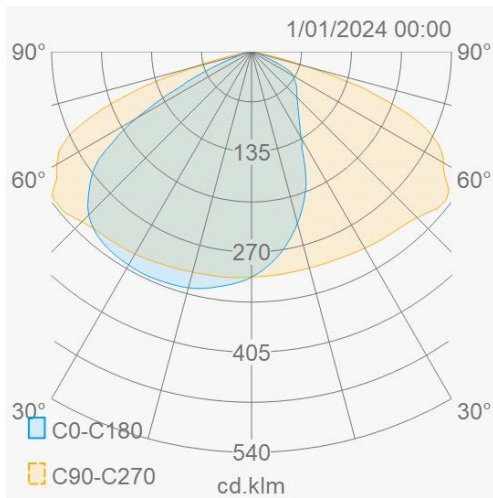

**Distance curve**

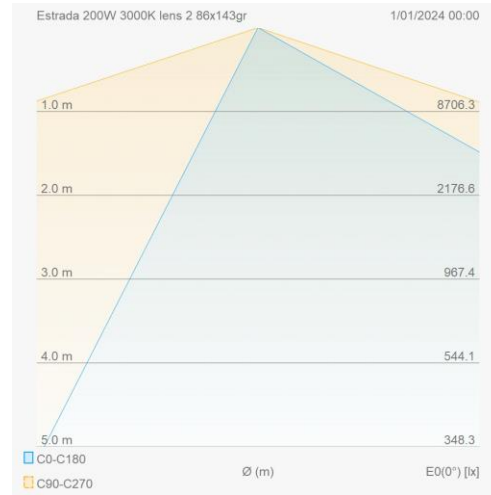

**Aansluitschema**

