

Outdoor Line - Terrein verlichting

Artikelnummer E2T040S43 - Streetlight Estrada 40W 3000K grijs lens 4

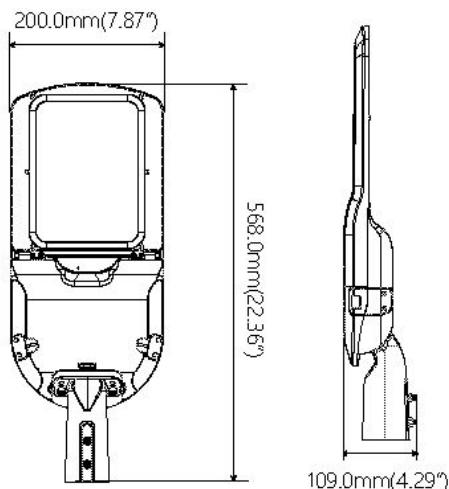

Paaltoparmatuur in aluminium behuizing IP66 IK08 grijs RAL9006 met lens type 4 86x143gr. Geschikt voor horizontale of verticale paalbevestiging van 60mm. 7 jaar garantie.

Elektrische eigenschappen

Voeding (Vac)	120~277	Frequentie (Hz)	50~60
Systeem vermogen (W)	40	Power factor	0,97
Merk driver	Sosen	Driver inbegrepen	Ja
Driver referentie	SS-35EP-50B	Driver CC/CV	CC
Isolatieklasse	1	Driver in/extern	Intern
Doorvoerbedrading	Nee	Kabelingang mm ²	1,5~4
Driver efficiëntie (%)	89	Driver THD < (%)	15
Driver uitgangsvoltage (VDC)	28~50	Driver uitgangsstroom (mA)	550~920
Dimbaar	Nee	Flicker free	Ja
PstLM flicker index	1	SVM strobo effect	0,4
Inrush current	45A 110µs	B16 #	27
C16 #	45	ENEC	Ja
Overspanningsbeveiliging (kV)	6		

Lichttechnische eigenschappen

Reflector (°)	122x142	CCT (K)	3000~3000
CRI >	70	SDCM <	5
Lumen output (Lm)	5672	Lm/W	150
Energie klasse	D	Garantie (jaar)	7
Levensduur L90B10	46000	Levensduur L80B10	96000
Ledchip	3030	Merk ledchip	Lumileds

Eigenschappen behuizing

Afmetingen (mm)	568x200x109 mm	Bruto gewicht (kg)	4,11
IP waarde	66	EPA	0,091
IK waarde	08	Kleur	Grijs
RAL kleur	9006	Behuizing	Aluminium
Diffuser	Glas	Richtbaar	Ja
Ta (°C)	-30~50	UV bestendig	Ja
Glow wire test (°C)	850	Schroeven	RVS L304

Outdoor Line - Terrein verlichting

Artikelnummer E2T040S43 - Streetlight Estrada 40W 3000K grijs lens 4

Lumen distributie

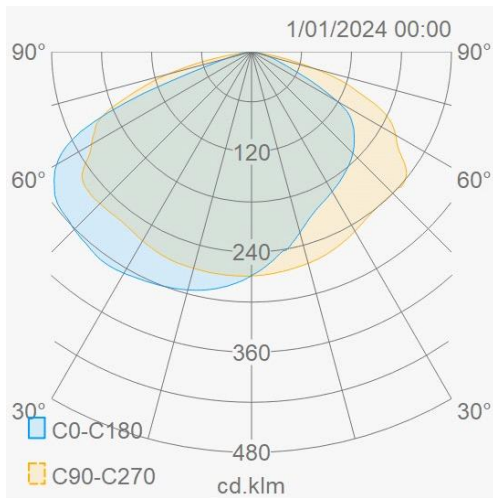

Distance curve

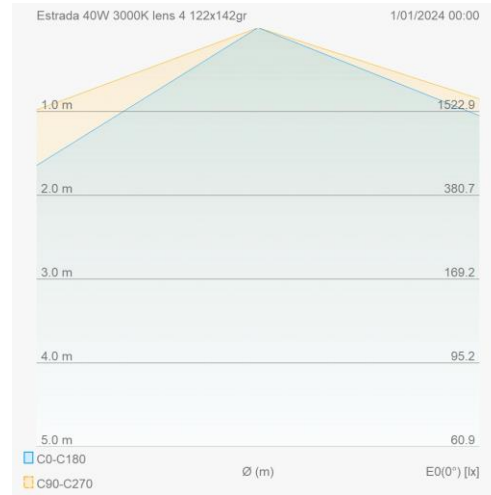

Aansluitschema

