

Outdoor Line - Floodlights runners

Artikelnummer BMF2040B - Schijnwerper Beam Mini 20W 4000K IP65 IK07 zwart

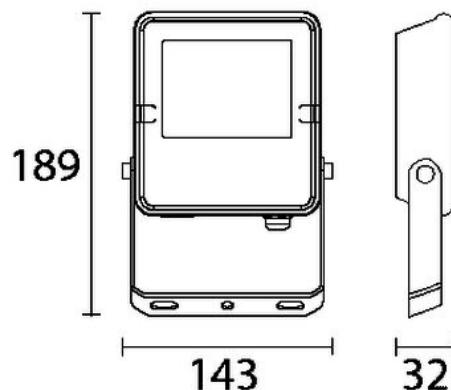

Elektrische eigenschappen

Voeding (Vac)	220~240	Frequentie (Hz)	50~60
Systeem vermogen (W)	20	Driver inbegrepen	Ja
Driver CC/CV	DOB	Isolatieklasse	1
Driver in/extern	Intern	Doorvoerbedrading	Nee
Met aansluitkabel	3G1,5 H05RNF	Kabel lengte (m)	1,5
Dimbaar	Nee	ENEC	Nee

Lichttechnische eigenschappen

Reflector (°)	110	CCT (K)	4000~4000
CRI >	80	UGR <	28
SDCM <	5	Lumen output (Lm)	2200
Lm/W	110	Fotobio klasse	RG1
Energie klasse	E	Garantie (jaar)	3
Levensduur L80B50	50.000	Ledchip	SMD2835

Eigenschappen behuizing

Afmetingen (mm)	189x143x32 mm	Bruto gewicht (kg)	0,53
Bulkverpakking	30	IP waarde	65
IK waarde	07	Kleur	Zwart
RAL kleur	RAL9017	Behuizing	Aluminium
Richtbaar	Ja	Ta (°C)	-20~45
UV bestendig	Ja	Schroeven	RVS L304
Wartel	M16 messing vern		

Outdoor Line - Floodlights runners

Artikelnummer BMF2040B - Schijnwerper Beam Mini 20W 4000K IP65 IK07 zwart

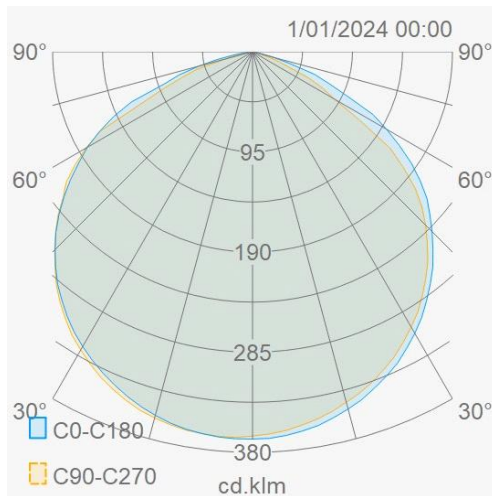

Lumen distributie

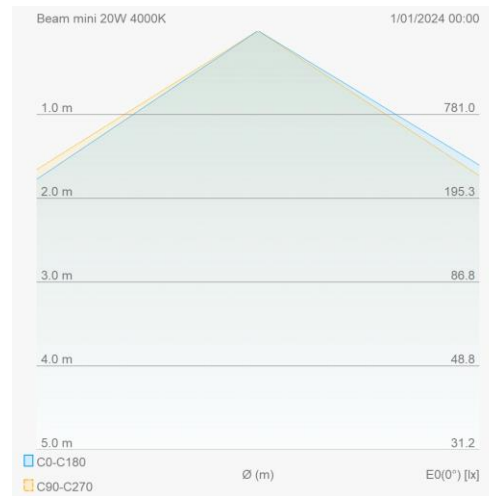

Distance curve



Montage toebehoren

BMBR80B	Schijnwerper Beam muurstang 80cm zwart	
WP67CONB	IP67 connector 3x2,5mm ² zwart	

BMGR16B	Schijnwerper Beam grondpin 160x38mm zwart	
---------	--	---

Aansluitschema

