

Industrial Line - Highbays

Artikelnummer AUR851504G - Aurora 150W 4000K 85gr IP66 IK10 ballproof

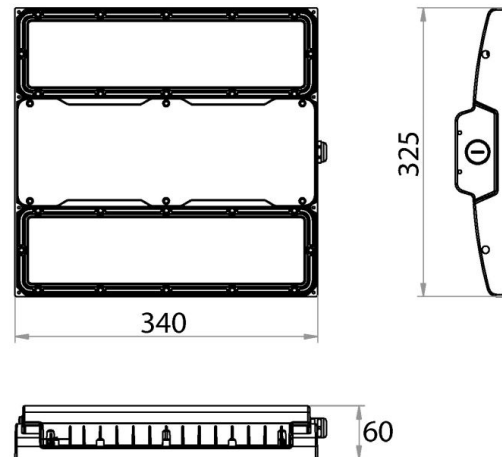

Linear highbay ballproof armatuur volgens DIN 18032-3 geschikt voor opbouw- of pendelmontage.

Elektrische eigenschappen

Voeding (Vac)	220~240	Frequentie (Hz)	50~60
Systeem vermogen (W)	150	Power factor	0,98
Merk driver	Sosen	Driver inbegrepen	Ja
Driver referentie	SS-150GA	Driver CC/CV	CC
Isolatieklasse	1	Driver in/extern	Intern
Doorvoerbedrading	Nee	Kabelingang mm ²	0,75~2,5
Driver efficiëntie (%)	92	Driver THD < (%)	10
Driver uitgangsvoltage (VDC)	22~56	Driver uitgangsstroom (mA)	2100~4200
Dimbaar	Nee	Flicker free	Ja
PstLM flicker index	1	SVM strobo effect	0,4
Inrush current @ 230Vac	110A 200µs	B16 #	5
C16 #	9	ENEC	Nee
Overspanningsbeveiliging (kV)	10		

Lichttechnische eigenschappen

Reflector (°)	85	CCT (K)	4000~4000
CRI >	80	SDCM <	3
Lumen output (Lm)	23250	Lm/W	155
Fotobio klasse	RG1	Energie klasse	D
Garantie (jaar)	5	Levensduur L80B50	L80 82.000
Ledchip	3030		

Eigenschappen behuizing

Afmetingen (mm)	340x325x60 mm	Bruto gewicht (kg)	4,4
Bulkverpakking	1	IP waarde	66
IK waarde	10	Kleur	Grijs
Behuizing	Aluminium	Diffuser	PC
Ta (°C)	-30~50	UV bestendig	Ja
Glow wire test (°C)	850	Ball proof	Ja

Industrial Line - Highbays

Artikelnummer AUR851504G - Aurora 150W 4000K 85gr IP66 IK10 ballproof

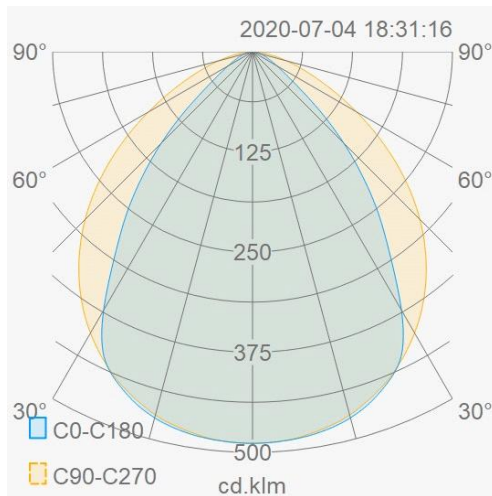

Lumen distributie

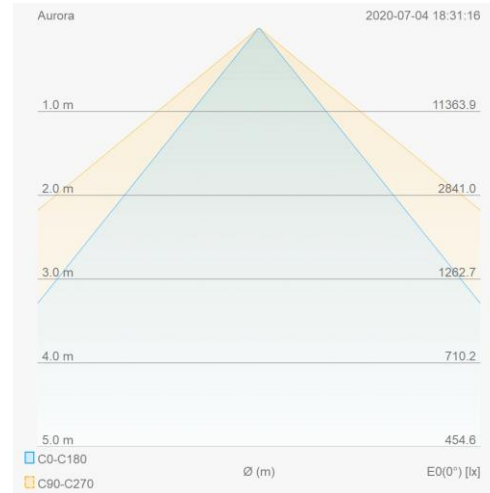

Distance curve



Montage toebehoren

AURBRACK1	Montagebeugel Aurora vast	
AURBRACK3	Pendelset Aurora staalkabel 1m	

AURBRACK2	Opbouwbeugel Aurora richtbaar	
AURPEND1	Pendelset Aurora ketting 1m	