

AQUALIA

Aqualia CTA 0,6m 12~20W3/4/5000K 150lm/W IK08 mw sensor

Industrial Line - HWD

AQP06KCMW

EAN: 05404042600191

ETIM: EC002892

Spatwaterdicht led armatuur Aqualia CTA 0,6m IP66 IK08 met instelbare vermogen 12/14/17/20W en instelbare kleurtemperatuur 3000/4000/5000K. Uitgerust met microwave sensor, instelbaar met DIP-switches.

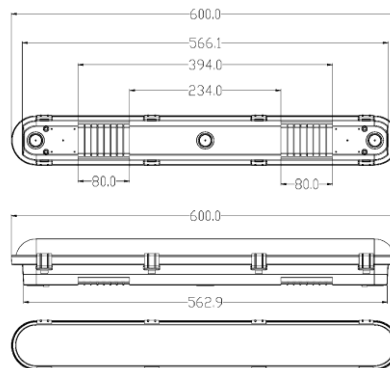

Elektrische eigenschappen

Voeding (Vac)	220~240
Voeding (Vdc)	180~264
Frequentie (Hz)	50~60
Vermogen instelbaar	Ja
Led vermogen (W)	20
Power factor	0,95
Merk driver	Lifud
Driver referentie	LF-FMR020YS
Driver inbegrepen	Ja
Driver CC/CV	CC
Isolatieklasse	1
Driver in/extern	Intern
Doorvoerbedrading	Ja
Doorvoerbedrading mm ²	2,5
Kabelingang mm ²	0,75~2,5
Bedrading halogeenvrij	Ja
Met aansluitkabel	LSOH
Driver efficiëntie (%)	85
Driver THD < (%)	20
Driver uitgangsvoltage (VDC)	25~57
Driver uitgangsstroom (mA)	200~350
Dimbaar	Nee
Flicker free	Ja
PstLM flicker index	1
SVM strobo effect	0,4
Inrush current @ 230Vac	19A 150µs
B16 #	47
C16 #	78
ENEC	Ja

Lichttechnische eigenschappen

Reflector (°)	110
CCT (K)	3000~5000
CCT instelbaar	Ja
CRI >	80
SDCM <	3
Lumen output (Lm)	3000
Lm/W	150
Fotobio klasse	RG0
Energie klasse	D
Garantie (jaar)	5
Levensduur L80B50	124.000
Levensduur L80B10	91.000
Levensduur L90B50	67.000
Levensduur L90B10	49.000
Ledchip	SMD2835
Merk ledchip	Epistar

Specificaties sensor

Sensor type	Microwave
Sensor output	230V
Sensor merk	Merrytek
Sensor instelling	DIP-switch
Sensor referentie	MC098S
Combi driver/sensor	Nee
Detectiehoek (°)	360/150
Detectiehoogte (m)	6
Detectie radius (m)	2-8
Gevoeligheid (%)	25/50/75/100
Daglicht (Lx)	2/10/30/50/uit
Timer bereik	5s/30s/90s/5m/20m/30
Dim bereik (%)	N
Standby tijd	N
Master/slave	Ja
Corridor functie	Nee

Eigenschappen behuizing

Afmetingen (mm)	600x83x74 mm
Bruto gewicht (kg)	1,05
Bulkverpakking	20
IP waarde	66
IK waarde	08
Kleur	Grijs
Behuizing	ABS
Diffuser	PC opaal
Ta (°C)	-20~60
UV bestendig	Ja
Glow wire test (°C)	850
Chloor bestendig	Nee
HACCP	Nee
Ball proof	Nee
Schroeven	RVS L304
Wartel	M20 ABS

Lumenwaardes

12W - 3000K - 1710lm - dip-switch	12W - 4000K - 1800lm - dip-switch
12W - 5000K - 1890lm - dip-switch	14W - 3000K - 1995lm - dip-switch
14W - 4000K - 2100lm - dip-switch	14W - 5000K - 2205lm - dip-switch
17W - 3000K - 2423lm - dip-switch	17W - 4000K - 2550lm - dip-switch
17W - 5000K - 2678lm - dip-switch	20W - 3000K - 2850lm - dip-switch
20W - 4000K - 3000lm - dip-switch	20W - 5000K - 3150lm - dip-switch

AQUALIA

Aqualia CTA 0,6m 12~20W3/4/5000K 150lm/W IK08 mw sensor
Industrial Line - HWD

AQP06KCMW

EAN: 05404042600191
ETIM: EC002892

Lumen distributie

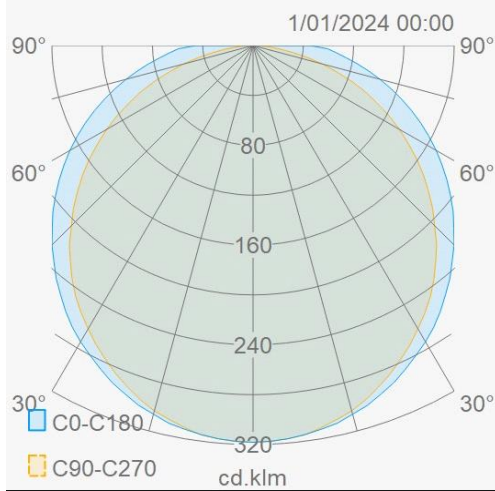

Distance curve

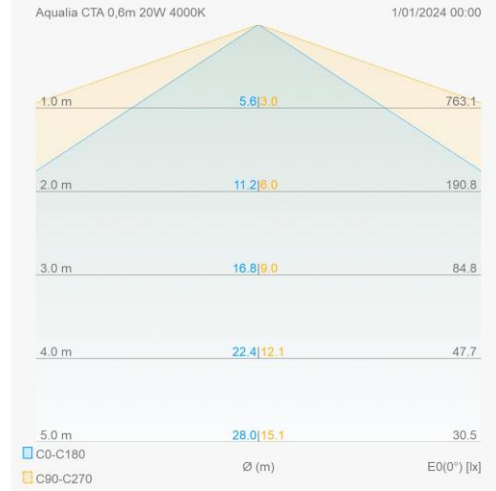

Montage toebehoren

AQPENDM1 Pendelset Aqualia 1m



AQPENDM5 Pendelset Aqualia 5m



Detectiepatroon sensor

Ceiling mounted height: 3m
Sensitivity: 100%/75%/50%/25%

Ceiling mounted height: 6m(*)
Sensitivity: 100%/75%

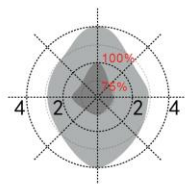
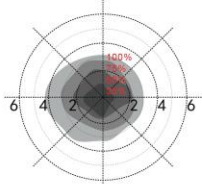
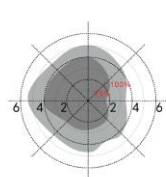
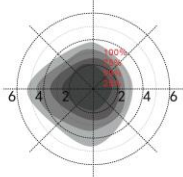

Aansluitschema

