

## DESKY ACC

Panneau led Deskly 295x1195 48W 4000K CRI>90 UGR<19

Utility Line - Led paneel runners

**DSU301204**

EAN: 05404042601181

ETIM: EC002892

Panneau LED Deskly Plus avec couverture microprismatique UGR<19 CRI>90. Toujours commander par panneau le driver séparément max. 48W.

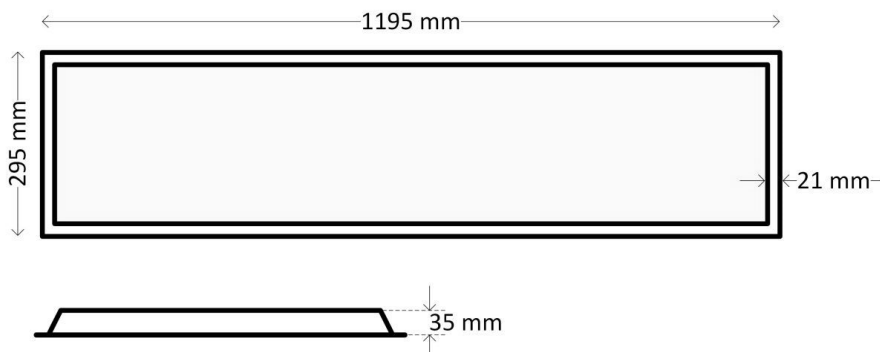
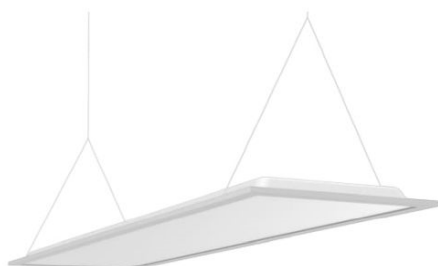

### Caractéristiques électriques

Alimentation (Vdc)	20~50
Fréquence (Hz)	DC~
Puissance système (W)	48
Puissance LED (W)	45
Driver inclus	Non
Driver CC/CV	CC
Classe d'isolation	3
Driver in/externe	Externe
Câblage traversant	Oui
Entrée de câble mm <sup>2</sup>	0~0
Avec câble de raccordement	H03
Longueur du câble (m)	0,3
Options dimming	1-10V/DALI/TRIAC
ENEC	Oui

### Caractéristiques d'éclairage

Reflecteur (°)	90
CCT (K)	4000~4000
CRI >	90
UGR <	19
SDCM <	3
Puissance lumineuse (Lm)	6480
Lm/W	125
Class Photobio	RG0
Classe énergie	E
Garantie (ans)	7
Durée de vie L90B50	54.000
Durée de vie L80B50	113.000
Ledchip	SMD2835
Marque ledchip	Epistar

### Caractéristiques boîtier

Dimensions (mm)	1195x295x35 mm
Poids brut (kg)	3
Emballage en vrac	6
Valeur IP	40
Valeur IK	03
Couleur	Blanc
Couleur RAL	9016
Boîtier	Aluminium
Diffuseur	PS microprisma
Ta (°C)	0~40
Résistant aux UV	Oui
Glow wire test (°C)	850
Résistant au chlore	Non
HACCP	Non
Ball proof	Non

### Valeurs lumineuses

18W - 4000K - 2250lm - DSD18W	0W - 4000K - 3000lm - DSD24W
0W - 4000K - 3750lm - DSD30W	0W - 4000K - 4500lm - DSD36W
0W - 4000K - 5625lm - DSD45WD	0W - 4000K - 6000lm - DSD48W

## DESKY ACC

Panneau led Deskly 295x1195 48W 4000K CRI>90 UGR<19  
Utility Line - Led panel runners

**DSU301204**

EAN: 05404042601181  
ETIM: EC002892



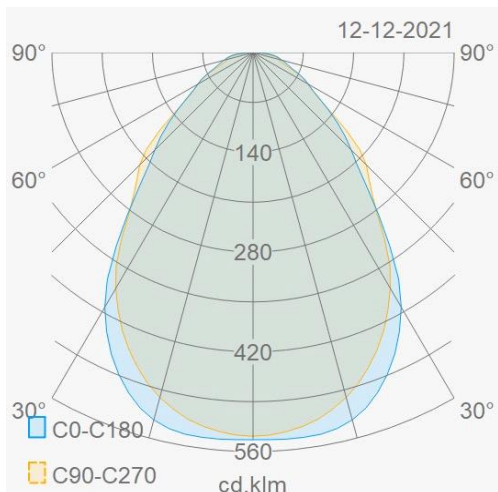



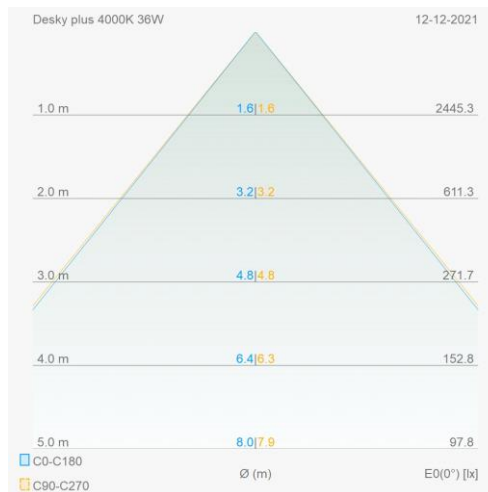







### Distribution flux lumineux



### Courbe de distance



### Accessoires de montage

DSD30W	Driver panneau led Deskly/Ando 30W non réglable		DSD36W	Driver panneau led Deskly/Ando 36W non réglable	
DSD30WDA	Driver panneau led Deskly/Ando 30W réglable DALI2		DSD36WDA	Driver panneau led Deskly/Ando 36W réglable DALI2	
DSD30W110	Driver panneau led Deskly/Ando 30W réglable 1-10V		DSD36W110	Driver panneau led Deskly/Ando 36W réglable 1-10V	
DSD30WD	Driver panneau led Deskly/Ando 30W réglable TRIAC		DPR301205FR	Cadre apparent Deskly 300x1200x70 blanc RAL9016	
DSF30120RFR	Cadre encastré Deskly 1200x300 wit RAL9016		DSR5C6	Set 6 clips à ressort pour Deskly 1200x300	
DSPEND4H1	Set suspendu Deskly avec 4 points 1,5m		DSPEND4H5	Set suspendu Deskly avec 4 points 5m	
DSSAFC1	Deskly protection anti-chute avec crochet		DSD48W	Driver panneau led Deskly/Ando 48W non réglable	
DSD48WDA	Driver panneau led Deskly/Ando 48W réglable DALI2		DSD48W110	Driver panneau led Deskly/Ando 48W réglable 1-10V	
DSD45WD	Driver panneau led Deskly/Ando 45W réglable TRIAC				

### Schéma de câblage

