

LED FLEX

DOT644020

Ruban led nodots 24V 5W/m IP20 CRI90 4000K 5m

Linear Line - Ledstrips

ETIM: EC002706

Ruban led nodots sans points lumineux visibles grâce à 256 puces LED SMD2025 recouvertes avec une couche de silicone blanc avec du phosphore.



Caractéristiques électriques

Alimentation (Vdc)	21~24
Fréquence (Hz)	DC~
Puissance système (W)	5,2
Puissance LED (W)	5
Driver inclus	Non
Câblage traversant	Non
Avec câble de raccordement	H03VV-F
Longueur du câble (m)	1
Dimmable	PWM
ENEC	Non

Caractéristiques boîtier

Dimensions (mm)	5000x8x3,5 mm
Poids brut (kg)	0,2
Emballage en vrac	60
Valeur IP	20
Valeur IK	00
Couleur	Blanc
Boîtier	Flex PCB
Ta (°C)	-20~45
Résistant au chlore	Non
HACCP	Non
Ball proof	Non

Caractéristiques d'éclairage

Reflecteur (°)	140
CCT (K)	4000~4000
CRI >	90
SDCM <	3
Puissance lumineuse (Lm)	701
Lm/W	130
Class Photobio	RG0
Classe énergie	E
Garantie (ans)	5
Durée de vie L80B10	60.000
Ledchip	SMD2025
Marque ledchip	San'an

Caractéristiques ruban LED

Watt/m	5
LEDs/m	256
Longueur coupe (mm)	31,25
Rayon de courbure (mm)	60
Longueur maximale (m)	5
Cuivre épaisseur (Oz)	2

Schéma de câblage

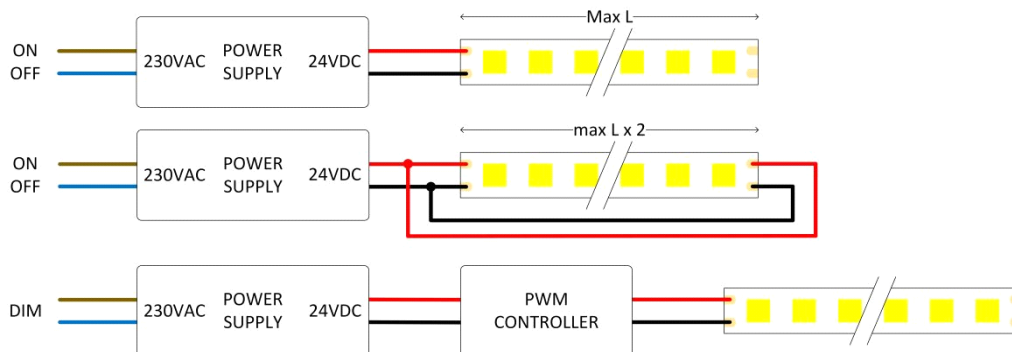

LED FLEX

Ruban led nodots 24V 5W/m IP20 CRI90 4000K 5m

Linear Line - Ledstrips

DOT644020

ETIM: EC002706



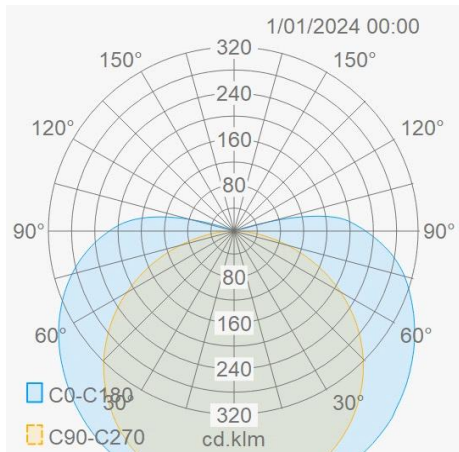



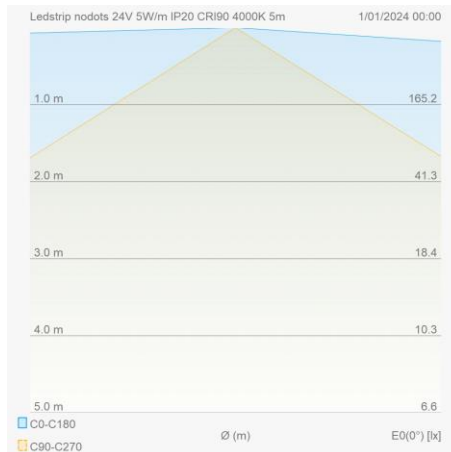

Distribution flux lumineux



Courbe de distance



Accessoires de montage

LSCON82DOT	Ruban led connecteur 2p 8mm nodots 15cm câble		LSM82DOT	Machon ruban led 2p 8mm nodots	
LSMCAB82DOT	Machon ruban led 2p 8mm nodots 15cm câble		LSC9082DOT	Ruban led coude 90gr 2p 8mm nodots	
LSCON82SCREW	Ruban led connecteur avec vis 2p 8mm 24V 6A 0,75		LSM82SCREW	Machon ruban avec vis led 2p 8mm 24V 6A	
LSC9082SCREW	Ruban led coude avec vis 90gr 2p 8mm 24V 6A		CABFL2P50M	Flatcable mono 2x20awg 0,52mm ² 50m	

Profils compatibles

APR2308A2	APS1708B2	APS1818B3	APS3030W2	APX3270A2	EFL1616W2	EFL3030W3	PLU2531W2
APR2308B2	APS1708B3	APS1818W2	APS3030W3	APX4918A2	EFL1616W3	GRP2828A2	PLU2531W3
APR2308W2	APS1708W2	APS1818W3	APS3535A2	APX4918B2	EFL2020A2	PLG1715A2	PLU3136A2
APR2315A2	APS1708W3	APS2413A2	APS3535A3	APX4918W2	EFL2020A3	PLU1622A2	PLU3136A3
APR2315B2	APS1715A2	APS2413A3	APS3535B2	APX5314A	EFL2020B2	PLU1622A3	PLU3136B2
APR2315W2	APS1715A3	APS2413B2	APS3535B3	APX6214A	EFL2020B3	PLU1622B2	PLU3136B3
APR3013A2	APS1715B2	APS2413B3	APS3535W2	APXC4626	EFL2020W2	PLU1622B3	PLU3136W2
APR3013B2	APS1715B3	APS2413W2	APS3535W3	APXC5123	EFL2020W3	PLU1622W2	PLU3136W3
APR3013W2	APS1715W2	APS2413W3	APX1606A2	APXR21A2	EFL3030A2	PLU1622W3	PWG1715A
APR5035A2	APS1715W3	APS3030A2	APX1616A2	EFL1616A2	EFL3030A3	PLU2531A2	
APR5035B2	APS1818A2	APS3030A3	APX2020A2	EFL1616A3	EFL3030B2	PLU2531A3	
APR5035W2	APS1818A3	APS3030B2	APX2865TB	EFL1616B2	EFL3030B3	PLU2531B2	
APS1708A3	APS1818B2	APS3030B3	APX3030A2	EFL1616B3	EFL3030W2	PLU2531B3	