

Industrial Line - Cloches

Référence AUR851504GDA - Aurora 150W 4000K 85gr IP66 IK10 ballproof DALI

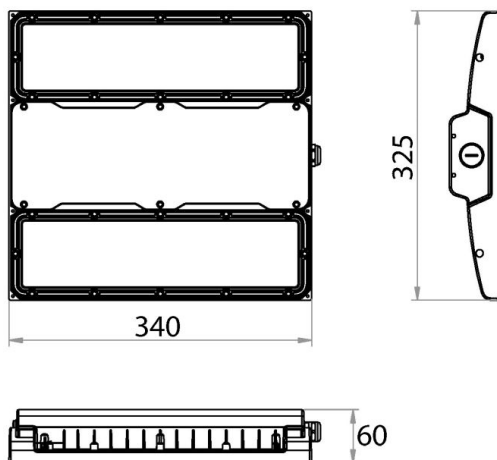

Highbay linéaire de grande hauteur ballproof conforme norme DIN 18032-3, montage apparent ou suspendu.

Caractéristiques électriques

| | | | |
|--------------------------------|------------|---------------------------------|----------|
| Alimentation (Vac) | 220~240 | Fréquence (Hz) | 50~60 |
| Puissance système (W) | 150 | Power factor | 0,95 |
| Marque driver | Sosen | Driver inclus | Oui |
| Référence driver | SS-150VP | Driver CC/CV | CC |
| Classe d'isolation | 1 | Driver in/externe | Interne |
| Câblage traversant | Non | Entrée de câble mm ² | 0,75~2,5 |
| Efficacité driver (%) | 92 | Driver DHT < (%) | 10 |
| Driver voltage de sortie (VDC) | 72~143 | Driver courant de sortie (mA) | 750~1500 |
| Dimmable | DALI2 | Flicker free | Oui |
| PstLM flicker index | 1 | SVM strobo effect | 0,4 |
| Inrush current @ 230Vac | 125A 200µs | B16 # | 5 |
| C16 # | 8 | ENEC | Non |
| Protection surtension (kV) | 10 | | |

Caractéristiques lumineuse

| | | | |
|--------------------------|-------|---------------------|------------|
| Reflecteur (°) | 85 | CCT (K) | 4000~4000 |
| CRI > | 80 | SDCM < | 3 |
| Puissance lumineuse (Lm) | 23250 | Lm/W | 155 |
| Class Photobio | RG1 | Classe énergie | D |
| Garantie (ans) | 5 | Durée de vie L80B50 | L80 82.000 |
| Ledchip | 3030 | | |

Caractéristiques boîtier

| | | | |
|---------------------|---------------|------------------|------|
| Dimensions (mm) | 340x325x60 mm | Poids brut (kg) | 4,4 |
| Emballage en vrac | 1 | Valeur IP | 66 |
| Valeur IK | 10 | Couleur | Gris |
| Boîtier | Aluminium | Diffuseur | PC |
| Ta (°C) | -30~50 | Résistant aux UV | Oui |
| Glow wire test (°C) | 850 | Ball proof | Oui |

Industrial Line - Cloches

Référence AUR851504GDA - Aurora 150W 4000K 85gr IP66 IK10 ballproof DALI

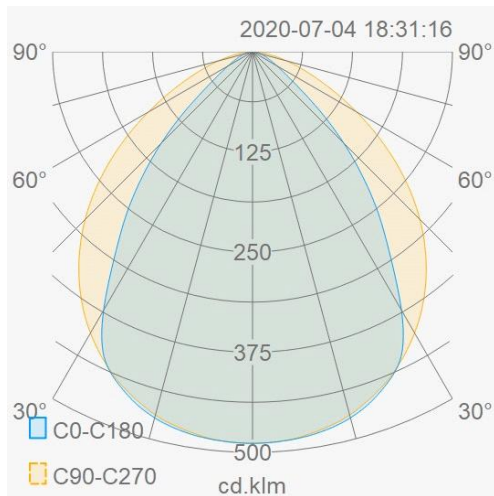

Distribution flux lumineux



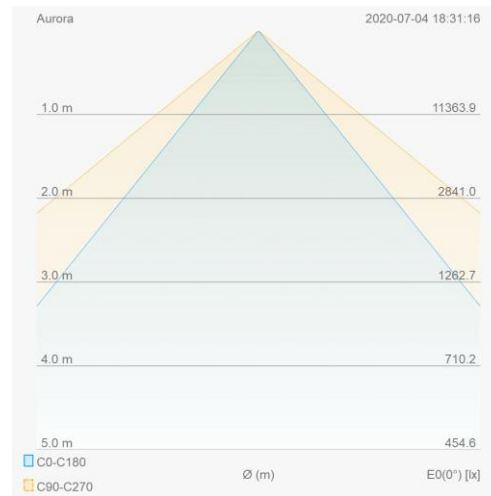

Courbe de distance



Accessoires de montage

| | | |
|-----------|--------------------------------------|---|
| AURBRACK1 | Support de montage Aurora fixe |  |
| AURBRACK3 | Set suspendu Aurora câble d'acier 1m |  |

| | | |
|-----------|------------------------------------|---|
| AURBRACK2 | Support de montage Aurora réglable |  |
| AURPEND1 | Set suspendu Aurora chaîne 1m |  |