

ALLROUND

ALR800IN503W

Allround 800mm IN 50W 3000K 39x18mm blanc

Utility Line - Plafonniers

Luminaire suspendu en forme d'anneau, livré avec un driver et un kit de suspension de 2 mètres. Peut être suspendu directement au plafond ou avec une rosace de plafond en option.

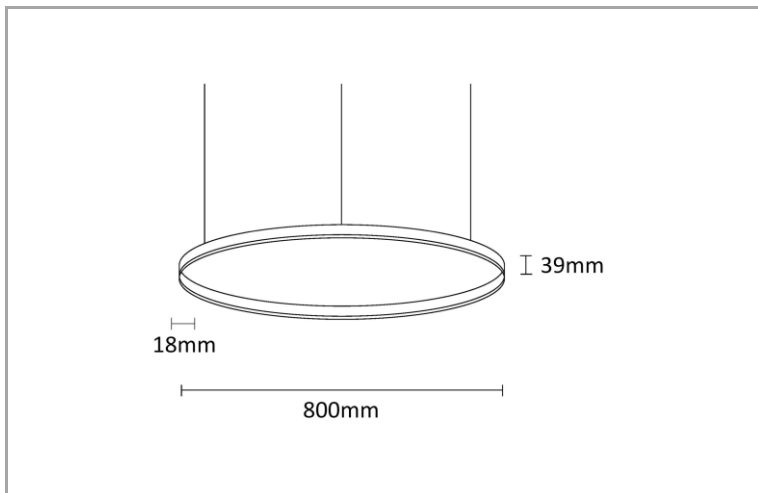

IP40



3



IK05



110°



100Lm/W



CRI80



-20 ~ 45 °C



SDCM < 3

Caractéristiques électriques

Alimentation (Vac)	100~277
Fréquence (Hz)	50~60
Puissance système (W)	55
Puissance LED (W)	50
Power factor (full load)	0,92
Marque driver	Boke
Driver inclus	Oui
Driver CC/CV	CC
Classe d'isolation	1
Driver in/externe	Externe
Câblage traversant	Non
Entrée de câble mm ²	0,75~2,5
SELV driver	Oui
Efficacité driver (%)	90
Driver DHT < (%)	10
Dimmable	Non
Flicker free	Oui
PstLM flicker index <	1
SVM strobo effect <	0,4
Inrush current @ 230Vac	18,3A 300µs
B16 #	23
C16 #	38
ENEC	Non
ISO	ISO 9001:2015

Caractéristiques d'éclairage

Reflecteur (°)	110
CCT (K)	3000~3000
CRI >	80
UGR <	30
SDCM <	3
Puissance lumineuse (Lm)	5000
Lm/W jusqu'à	100
Class Photobio	RG0
Classe énergie	F
Flux code	15 40 72 100 100
Garantie (ans)	3
Durée de vie L80B10	50.000
Ledchip	SMD2835
Marque ledchip	Sanan

Caractéristiques boîtier

Boîtier	Aluminium
Dimensions (mm)	800x17,7x39 mm
Couleur	Blanc
Diamètre extérieur (mm)	800
Forme	Ronde
Couleur RAL	9016
Diffuseur	Silicone
Emballage en vrac	1
Poids brut (kg)	14,45
Valeur IP	40
Valeur IK	05
Ta (°C)	-20~45

ALLROUND

ALR800IN503W

Allround 800mm IN 50W 3000K 39x18mm blanc

Utility Line - Plafonniers

Distribution flux lumineux



Schéma de câblage



Accessoires de montage

ALRCNK8121500W

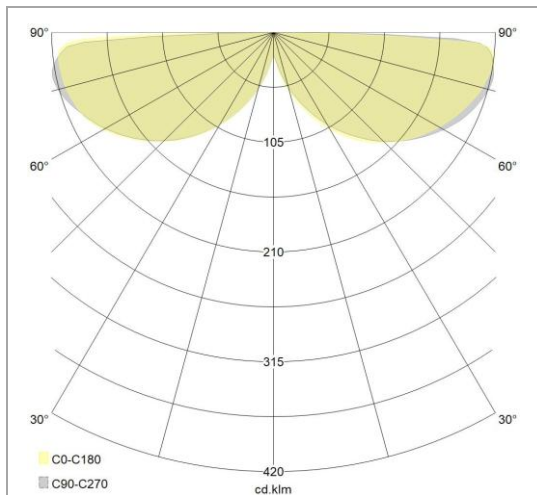
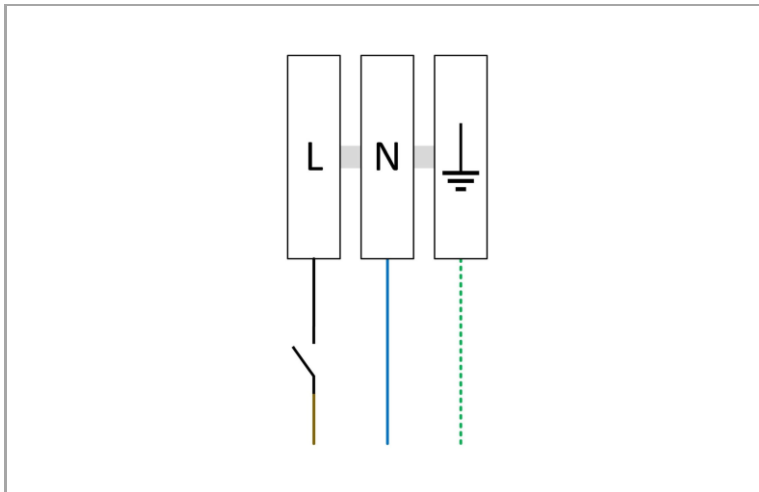
Allround rosace de plafond pour
800/1200/1500mm blanc



ALRSUSW6M

Allround set de suspendu 6m blanc

